

C41R2 and KBIC-120

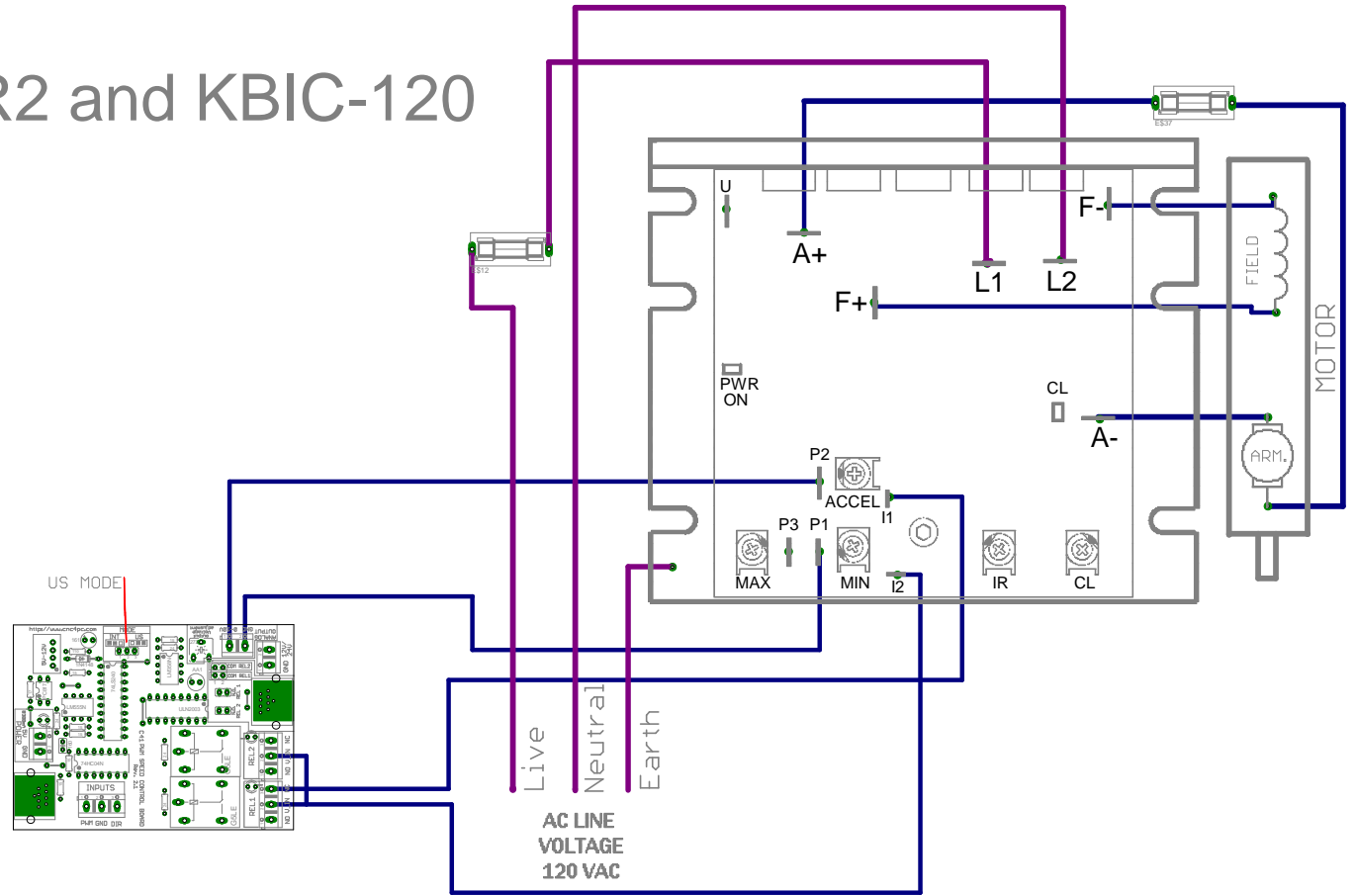

- Make sure the grounds of the analog circuit are kept isolated from the logic (+5vdc). Use a multimeter to confirm there is no continuity between the two grounds before applying power.
- Please consult the inverter manual and confirm this wiring works for your unit.

Note:
This wiring is just to illustrate a sample product application.
Specific wiring may vary from system to system.
It is the user's responsibility to implement it correctly.

US MODE				
C32 PIN		RELAYS		SPINDLE OPERATION
1_14	1_16	REL. 1	REL. 2	
PWM	ON	OFF	ON	Spindle ON CCW
PWM	OFF	ON	OFF	Spindle ON CW
OFF	ON	OFF	OFF	Spindle OFF
OFF	OFF	OFF	OFF	Spindle OFF

INT MODE				
C32 PIN		RELAYS		SPINDLE OPERATION
1_14	1_16	REL. 1	REL. 2	
PWM	ON	ON	ON	Spindle ON CCW
PWM	OFF	ON	OFF	Spindle ON CW
OFF	ON	OFF	OFF	Spindle OFF
OFF	OFF	OFF	OFF	Spindle OFF

CNC4PC
<http://www.cnc4pc.com>

Designed: YAC	Date: MAR-05-2013
Revised:	Date:
Item: C41R2 and KBIC	Ver.: 1
Description: C41R2 and KBIC-120	